



This user manual is applicable to:
Model: IT8518B/IT8518C/IT8518E/IT8518F



QUICK REFERENCE	7
THE FRONT PANEL	7
THE REAR PANEL	8
FRONT PANEL ANNUNCIATORS	8
KEY PAD	9
IMMEDIATE ACTION KEYS	9
MENU OPERATION	10
GENERAL INFORMATION	12
DOCUMENT ORIENTATION	12
GETTING STARTED MAP	12
OPTIONS AND ACCESSORIES	13
Options	13
Accessories	13
DESCRIPTION	13
FEATURES AND CAPABILITIES	13
FRONT PANEL CONTROLS	14
REMOTE PROGRAMMING	14
OPERATING MODES	14
Constant Current(CC)Mode	14
Constant Resistance (CR) Mode	14
Constant Voltage (CV) Mode	15
Constant Power (CW) Mode	15
TRANSIENT OPERATION	16
Continuous	16
Pulse	16
Trigger Mode	17
LIST OPERATION	17
TRIGGERED OPERATION	18
INPUT CONTROL	18
Short On/Off	18
Input On/Off	19
Operation Range	19
PROTECTION FEATURES	20
REMOTE SENSE FUNCTION	21
SAVING AND RECALLING SETTINGS	22
BATTERY TESTING	23
VON/VOFF OPERATION	24
INSTALLATION	25
INSPECTION	25
Damage	25

Items Supplied	25
Cleaning	25
LOCATION	26
Installation	27
BENCH OPERATION	27
INPUT CONNECTIONS	27
Power Cord	27
TURN-ON CHECKOUT	28
INTRODUCTION	28
CHECKOUT PROCEDURE	28
In Case of Trouble	29
FRONT PANEL OPERATION	30
EXAMPLE	30
I-set (set up a constant current from 0 to Max current)	30
P-set (set up a constant power from 0 to Max power)	31
R-set (set up a constant resistance from 0.1Ω to 4000Ω)	31
V-set (set up a constant voltage from 0.1V to Max voltage)	31
Shift + Store	32
Shift + Recall	32
In On/Off input setting	32
TRANSITION TESTING OPERATION	32
Transition Parameter Setting	32
Continuous Transient Operation	33
Pulse Transient Operation	33
Toggled Transient Operation	34
LIST OPERATION	34
FAST RECALL FUNCTION	36
AUTOMATIC TESTING FUNCTION OF ELECTRONIC LOAD	36
Edit the Testing File	37
Fast Recall the Test File	38
Automatic Testing	38
Select the Resolution between Low Range and High Range	39
SPECIFICATION	40
REMOTE OPERATION MODE	41
COMMUNICATION CABLE	41
COMMUNICATION BETWEEN ELECTRONIC LOAD AND PC	43

Warranty Information

Certification

We certify that this product met its published specifications at time of shipment from the factory.

Warranty

This hardware product is warranted against defects in material and workmanship for a period of ONE year from date of delivery. IT8500 series electronic load for use with a hardware product and when properly installed on that hardware product, are warranted not to fail to execute their programming instructions due to defects in material and workmanship for a period of 90 days from date of delivery. During the warranty period our company will either repair or replace products which prove to be defective. Our company does not warranty that the operation for the software firmware or hardware shall be uninterrupted or error free.

For warranty service, with the exception of warranty options, this product must be returned to a service facility designated by our company. Customer shall prepay shipping charges by (and shall pay all duty and taxes) for products returned to our place for warranty service. Our company shall pay for return of products to Customer.

Limitation of Warranty

The foregoing warranty shall not apply to defects resulting from improper or inadequate maintenance by the Customer, Customer-supplied software or interfacing, unauthorized modification or misuse, operation outside of the environmental specifications for the product, or improper site preparation and maintenance. Product number or serial number has been altered deleted, removed or were unable to identify. Damage from the accident, including but not limited to lightning, water, fire, abuse or negligence.

Assistance

The above statements apply only to the standard product warranty. Warranty options product maintenance agreements and customer assistance agreements are also available.

Safety Summary

The following general safety precautions must be observed during all phases of operation of this instrument. Failure to comply with these precautions or with specific warnings elsewhere in this manual violates safety standards of design, manufacture, and intended use of the instrument. We assume no liability for the customer's failure to comply with these requirements.

Environmental Conditions

This instrument is intended for indoor use. Pollution degree 2 environments. It is designed to operate at a maximum relative humidity of 95% and at altitudes of up to 2000 meters. Refer to the specifications tables for the ac mains voltage requirements and ambient operating temperature range.

Before Applying Power

Verify that all safety precautions are taken. Note the instrument's external markings described under "Safety Symbols".

Ground the Instrument

This product is a Safety Class 1 instrument (provided with a protective earth terminal). To minimize shock hazard, the instrument chassis and cover must be connected to an electrical ground. The instrument must be connected to the ac power mains through a grounded power cable, with the ground wire firmly connected to an electrical ground (safety ground) at the power outlet. Note: Any interruption of the protective (grounding) conductor or disconnection of the protective earth terminal will cause a potential shock hazard that could result in personal injury.

DO NOT OPERATE IN AN EXPLOSIVE ATMOSPHERE

Do not operate the instrument in the presence of fumes or flammable gases.

KEEP AWAY FROM LIVE CIRCUITS

Operating personnel must not remove instrument covers except as instructed in this Guide for installing or removing electronic load modules. Component replacement and internal adjustments must be made only by qualified service personnel. Do not replace components with power cable connected. Under certain conditions dangerous voltages may exist even with the power cable removed. To avoid injuries always disconnect power, discharge circuits, and remove external voltage sources before touching components.

DO NOT SERVICE OR ADJUST ALONE

Do not try to do some internal service or adjustment unless another person capable of rendering first aid resuscitation is present.

Safety Symbols



Direct current



Alternating current



Both direct and alternating current



Protective earth (ground) terminal



Caution (refer to accompanying documents)

Warning: The WARNING sign denotes a hazard. It calls attention to a procedure, practice, or the like, which, if not correctly performed or adhered to, could result in personal injury. Do not proceed beyond a WARNING sign until the indicated conditions are fully understood and met.

Caution: The CAUTION sign denotes a hazard. It calls attention to an operating procedure, or the like, which, if not correctly performed or adhered to, could result in damage to or destruction of part or all of the product. Do not proceed beyond a CAUTION sign until the indicated conditions are fully understood and met.

Quick Reference

The Front Panel

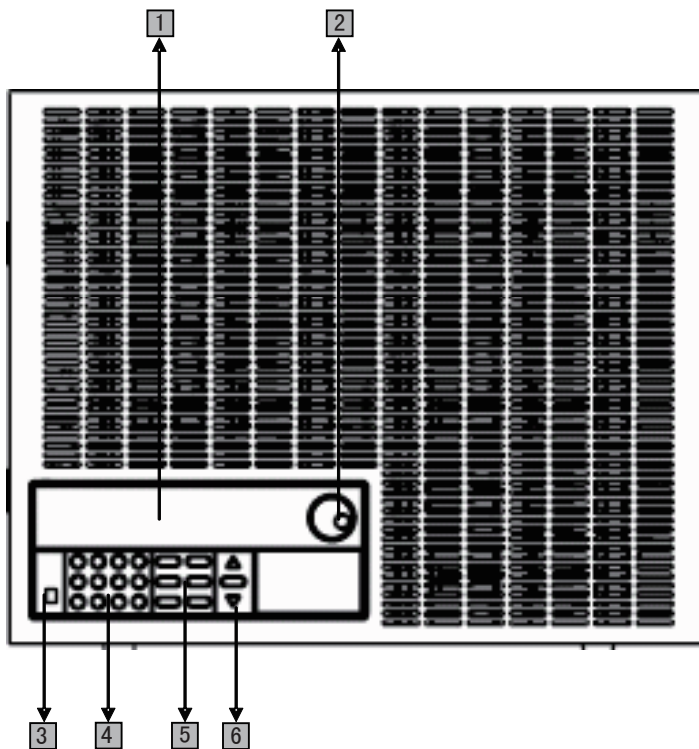

- 1 16-character display shows voltage and current measurements
- 2 Rotary knob
- 3 Power switch ON/OFF
- 4 Entry keys: (numeric keys)
Enter values
Increasing or decreasing the setup values
Menu commands
- 5 Keypad:
Enable/disable input.
Setup the current, resistance and voltage modes.
Set and reset protection functions.
- 6 Scroll through front panel.

The Rear Panel

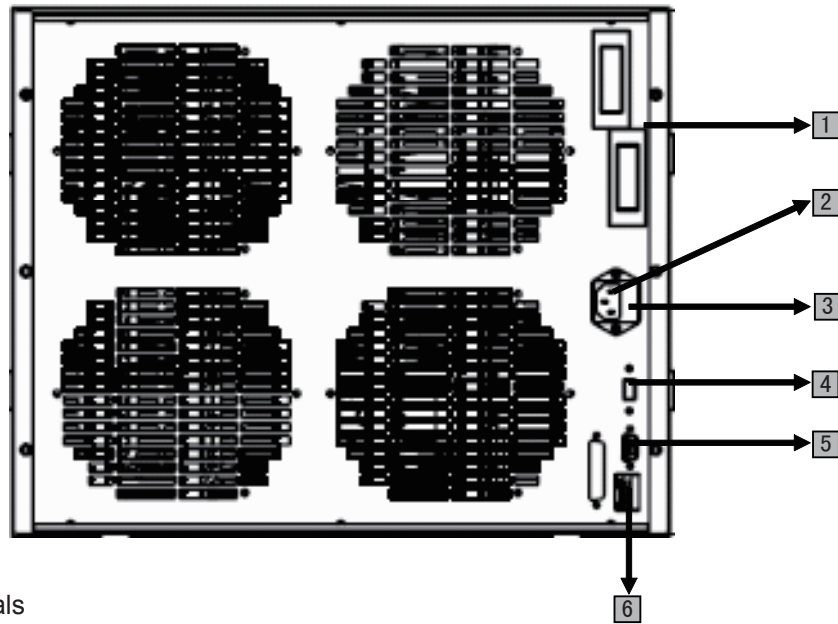

- 1 Input terminals
- 2 3 Pin IEC320 ac input connector
- 3 Fuse
- 4 Power switch (110V / 220V)
- 5 9-Pin COM port interface connector
- 6 4 Pin Trigger and Remote sensing connectors

Front Panel Annunciators

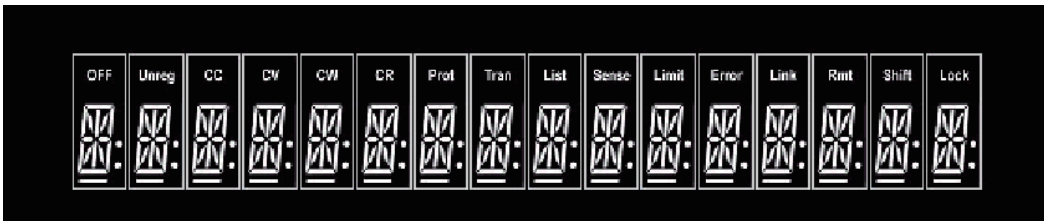

OFF	Front Panel Annunciators	Trigger	Indicates that the electronic load is waiting an initiate and trigger to occur.
CC	Constant current (CC) mode.	Sense	Indicates that the electronic load is in Remote sensing state
CV	Constant voltage (CV) mode.	Error	A errors have occurred
CW	Constant power (CW) mode.	Link	In the communication state
CR	Resistance (CR) mode.	Rmt	Indicates that the electronic load is in remote state (RS-232). In the remote state, only the active key is the Local key.
Tran	The input channel is enabled for transient operation.	Shift	Indicates that the shift key has been pressed.
List	List mode is initiated or running	Lock	keyboard is locked by password
Unr	The input is unregulated.		

Key Pad

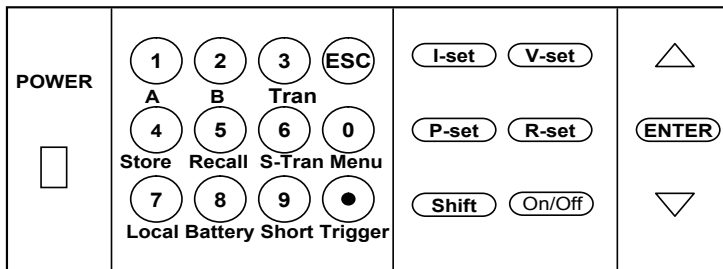

0 ~ 9	0 through 9 are used for entering numeric values.
●	Decimal point.
Esc	The escape key. It may used to exit any working state.
I-set	Choosing CC mode and setup the input current of regulation current mode.
V-set	Choosing CV mode and setup the input voltage of regulation voltage mode.
P-set	Choosing CW mode and setup the input watt of regulation power mode.
R-set	Choosing CR mode and setup the input resistor of regulation resistance mode.
Shift	Shift keys.
On/Off	Power ON/OFF
△	Scrolling keys let you move through the commands in the presently Select function menu, bring up the next command in the list. Function menus are circular; you can return to the starting position by continuous pressing the key.
▽	Go back to the previous command in the list .Function menus are circular; you can return to the starting position by continuous pressing the key.
Enter	Confirmation key.

Immediate Action Keys

Shift + A	Switch to A setting value
Shift + B	Switch to B setting value
Shift + Tran	Start /Stop transition operation
Shift + Store	Press to store an existing electronic load state in non-volatile Memory.
Shift + Recall	Press to recall an existing electronic load state in non-volatile Memory.
Shift + S-Tran	Set the transition operation parameter
Shift + Menu	Enter operation Menu.
Shift + Local	When the load is controlled by PC, press these keys to enable the front panel key
Shift + Battery	Battery discharge electronic operation
Shift + Short	Turn on or turn off short circuit Test.
Shift + Trigger	Causes a trigger to occur. Change the trigger source is IMMEDIATE

Menu Operation

Press Menu to indicate operation mode. View the menu in VFD and using ∇ and \triangle to scroll through the completely menu list as following. If press **Enter** key, you could get the selected menu function. Press **Esc** back to the previous menu selection page.

MENU		
CONFIG		
	INITIAL CONFIG	Return to the factory default setup value.
	INPUT RECALL	Setting Power-on state of Load.
	ON	When users turn on the electronic load; the electronic load setup value will keep the state of last time when users turn off the electronic load.
	OFF<DEFAULT>	Disable this function.
	POWER-ON RECALL	Setup of the electronic load input state in Power on.
	ON	When users turn on the electronic load; the electronic load input will keep the state of last time when users turn off the electronic load.
	OFF<DEFAULT>	When users turn on the electronic load, the electronic load input will keep the state off.
	KEY SOUND SET	Keypad sound setting.
	ON<DEFAULT>	Enable key sound.
	OFF	Disable key sound
	KNOB LOCK SET	Setup rotary knob lock state.
	ON	Lock Rotary knob
	OFF<DEFAULT>	Unlock Rotary knob.
	SHORT CUT RECALL	Quickly recall the data stored before
	ON	
	OFF>	
	RANGE SELECT	Change the measure precision of voltage and current
	EXTERNAL	
	OFF>	
	REMOTE SENSE	Setup voltage measurement Mode.
	ON	The electronic load will measure input voltage from the remote sense connector.
	OFF<DEFAULT>	The electronic load will measure input voltage from the front panel connector.
	ADC UPDATE RATE	
	HIGH	
	LOW<DEFAULT>	
	TRIGGER SOURCE	Choosing the trigger signals source.
	IMMEDIATE<DEF>	Trigger signals from Shift + Trigger key
	EXTERNAL	Trigger signals from the TRIG connector in the rear panel.
	BUS	Communication command trigger mode.
	CONNECT MODE	
	MAXTIDLEXING	
	SEPARATE<DEF>	

	BAUDRATE SET	Setting baud rate.
	4800<DEFAULT>	
	9600	
	19200	
	38400	
	COMM. PARITY SET	Command parity setting.
	NONE<DEFAULT>	
	EVEN	
	ODD	
	ADDRESS SET	Setting communication Flow mode
	KEY LOCK SET	Setting keypad password.
	EXIT	
	SYSTEM SET	
	MAX CURRENT SET	Setup the maximum current.
	MAX POWER SET	Setup the maximum power.
	MAX VOLTAGE SET	Setup the maximum voltage
	VOLTAGE ONSET	
	VOLTAGE OFFSET	
	EXIT	
	LIST SET	
	MODE SET	Setting operation mode.
	FIXED MODE	Fixed mode.
	LIST MODE	Choosing List mode.
	CALL LIST FILE	Recall list operation file.
	EDIT LIST FILE	Edit list operation file.
	LIST STORE MODE	Users can choose 4 kind of memory space to save the list file.
	8 X 120 STEPS	Total 8 files and each file have120 list steps.
	4 X 250 STEP	Total 4 files and each file have250 list steps.
	2 X 500 STEPS	Total 2 files and each file have500 list steps
	1 X 1000 STEPS	Total 1 file and each file have1000 list steps.
	EXIT	
	LOAD ON TIMER	
	TIMER STATE	Setting LOAD ON timer state
	ON	When users choose ON, and then turn on the electronic load input, the LOAD ON TIMER will start working. When the LOAD ON TIMER is reach the setup time, the electronic load input will turn offautomatically.
	OFF	
	TIMER SET	Setting time of LOAD ON timer.
	EXIT	
	EXIT	

General Information

Document Orientation

This manual describes the operation of the IT8500 series electronic loads. Unless otherwise noted, all units will be referred to by the description "electronic load" throughout this User's manual. The following documents and software are shipped with your electronic load. This User's Guide (this document), contains installation, checkout, front panel information and detailed programming information.

The Getting Started Map will help you find the information you need to complete the specific task that you want to accomplish. Refer to the table of contents or index of each guide for a complete list of the information contained within.

Getting Started Map

Task	Where to find information
Checking out the unit Verifying proper operation Using the front panel	User's Guide
Using the front panel Front panel keys Front panel examples	User's Guide
Using the programming interface RS-232 interface	User's Guide
Remote operation mode Protocol information	User's Guide
Controller Program and Software driver: Power View PV8500 software Active driver PD8500 OCX software	CD-ROM (If you've purchased the communication cable, you will get it for free)

Options and Accessories

Options

IT-E131 isolated communication cable: This cable converts the electronic load's series port (TTL 5V level) to PC RS232 interface.

IT-E132 isolated communication cable: This cable converts the electronic load's series port (TTL 5V level) to PC USB interface.

IT-E134 isolated communication cable: This cable converts the electronic load's series port (TTL 5V level) to PC GPIB interface.

Accessories

Power cord

User's manual

Software CD-Rom (if you buy the communication cable, you'll get it for free)

Calibration testing report

Description

The IT8500 series electronic load is used for design, manufacturing, and evaluation of DC power supplies, batteries, and power components and so on. The electronic load contains a processor, serial port connector, front-panel keypad and VFD, and other circuits common to the other entire load module. IT8500 series electronic load could work in constant current (CC) mode, constant voltage (CV) mode, or constant resistance (CR) mode and constant power (CW) mode.

Features and Capabilities

- High accuracy and high resolution
- Capable to work with constant current (CC), constant voltage (CV), constant resistance (CR) mode and constant power (CW) operation.
- Serial port interface-DB9-RS232 port.
- Triggered input and measurement functions.
- Within the controlled keypad in the front panel
- Built-in pulse generator for continuous, pulsed, and toggled transient mode operation.
- Over voltage, over current, overpower, and over temperature protection.
- Fan speed control by temperature.
- VFD display
- Short circuit test
- Battery testing function.

Front Panel Controls

The front panel has keyboard controls for setting the input voltage, current and resistance. The panel display provides digital readouts of a number of functions including the inputs. Annunciators display the operating status of the electronic load.

Remote Programming

The electronic load may be remotely programmed from the computer via the IT-E131 isolated communication cable.

Operating Modes

The four modes of operation are:

- 1: Constant current (CC)
- 2: Constant voltage (CV)
- 3: Constant resistance (CR)
- 4: Constant power (CW)

Constant Current(CC) Mode

In this mode, the electronic load will sink a current in accordance with the programmed value regardless of the input voltage. CC mode can be set with front panel keys. The CC mode parameters are discussed in the following paragraphs.

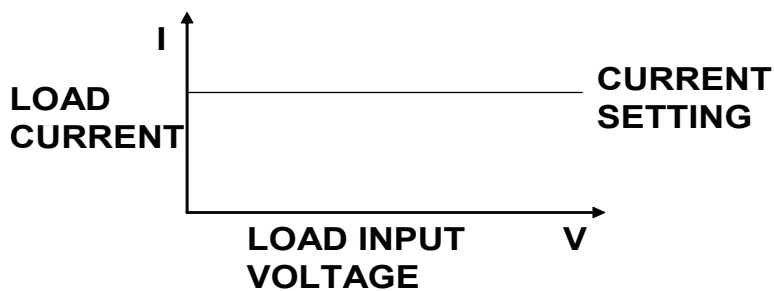

CONSTANT CURRENT MODE

Constant Resistance (CR) Mode

In this mode, the module will sink a current linearly proportional to the input voltage in accordance with the programmed resistance. The CR mode can be set at the front panel. The CR mode parameters are described in the following paragraph.

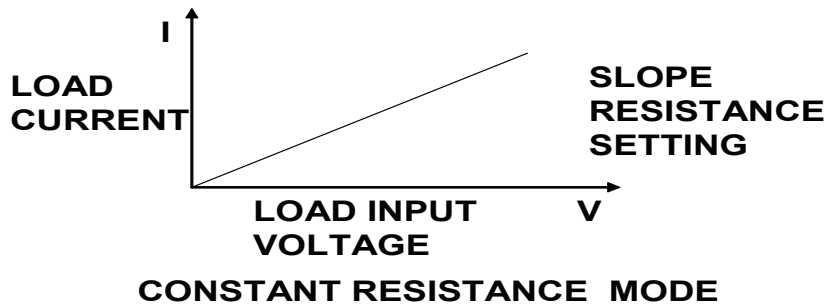

Constant Voltage (CV) Mode

In this mode, the electronic load will attempt to sink enough current to control the source voltage to the programmed value. The module acts as a shunt voltage regulator when operating in the CV mode. The CV mode can be set at the front panel.

The CV mode parameters are described in the following paragraphs.

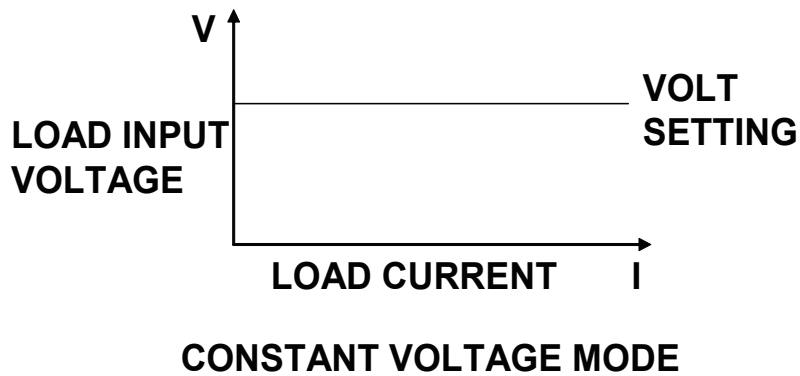

Constant Power (CW) Mode

In this mode, the electronic loads will consumption power accordance with the programmed value regardless of the input voltage. The CW mode can be set with front panel keys.

The CW mode parameters are discussed in the following paragraphs.

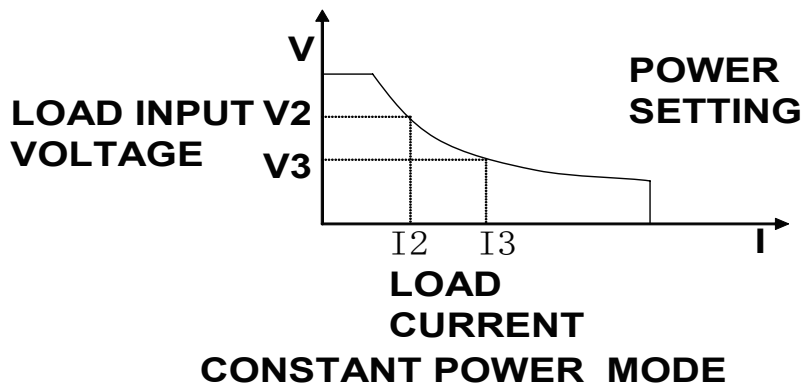

Constant Power (CW) Mode

In this mode, the electronic loads will consumption power accordance with the programmed value regardless of the input voltage. The CW mode can be set with front panel keys. The CW mode parameters are discussed in the following paragraphs.

Continuous

Generates a repetitive pulse stream the toggles between two load levels and change the state between value A and value B.

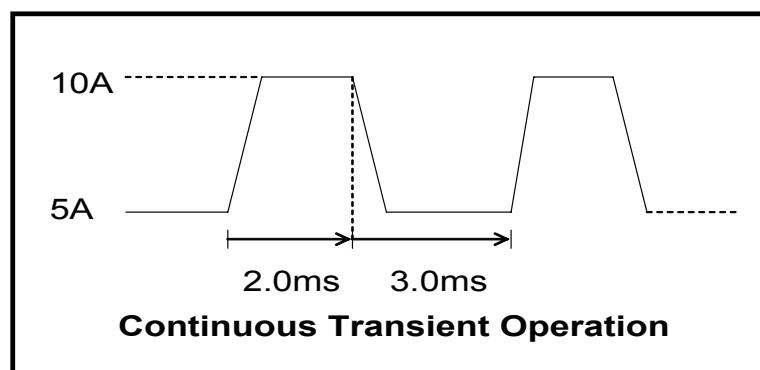

Pulse

Switch to value B as receiving one trigger signal, taking the pulse time(TWD) of value B, Load will return to Value A.

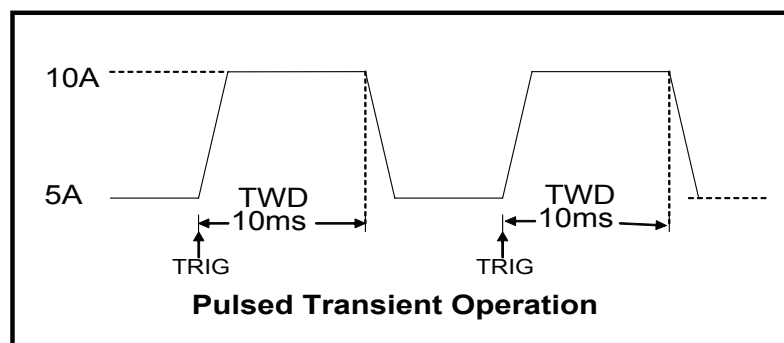

Trigger Mode

Switching the state between value A and value B once receiving a triggering signal

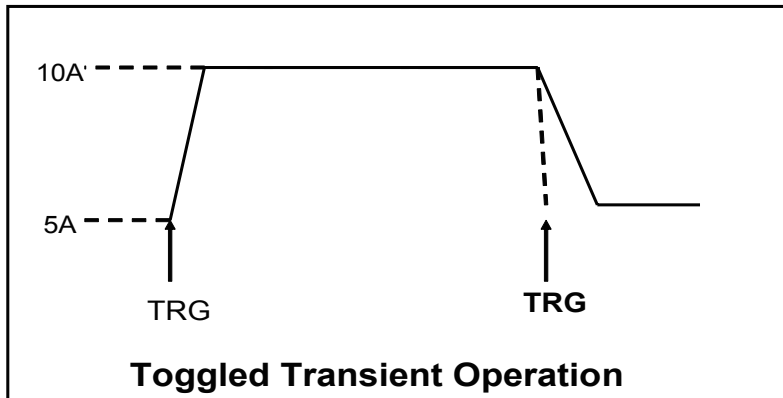

List Operation

List mode lets you generate complex sequences of input changes with rapid, precise timing, which may be synchronized with internal or external signals. List operation can be changed by edit every step value and time in list operation. The parameter of list operation include the group file name, input step setting (the max steps is 1000 steps), time of one step (1ms~1h) and setting value of one step. In CC mode, dwell time range is 1ms to 6S, which also have an associated value. Note that lists data can only be saved in total 1000 steps memory of 4 situations.

GROUP	Total = 1000 steps							
1	1000 steps							
2	500 steps				500 steps			
4	250 steps		250 steps		250 steps		250 steps	
8	120 steps	120 steps	120 steps	120 steps	120 steps	120 steps	120 steps	120 steps

When receiving one trigger signal, it will start the list operation until receiving another trigger signal or finish the List operation.

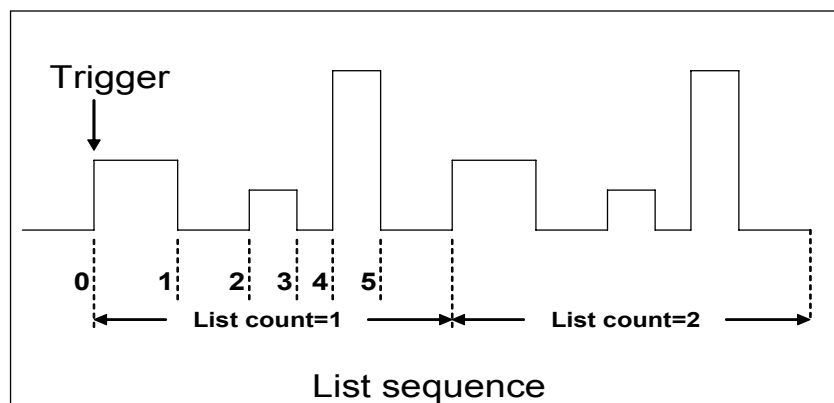

Triggered Operation

The electronic load has various triggering modes to allow synchronization with other test equipment or events. Such as:

Keypad triggering mode: Press **Shift** + **Trigger** to trigger the electronic load.

TTL triggering mode: Send a high pulse with a constant time more than 5m Sec to the trigger terminals in rear panel to trigger the electronic load.

Command triggering mode: Send triggering command to the electronic load via the serial port.

Input Control

Short On/Off

Load can simulate a short circuit at its input by turning the load on with full-scale current.

The shortcircuit can be toggled on/off at the front panel using the **Shift** + **Short** .

Short operation is not influence the operation setting current value , When short operation is on OFF state ,Load back to the original setting state.

The actual value of the electronic short is dependent on the mode and current range that are active when the short is turned on.

In CC, CW and CR mode, the max short-circuit current value is 1.2 times of the current range.

In CV mode, short-circuit operation is same as the operation of setting CV to 0V.

NOTE: Turning the Short Test on in CV mode may cause the load to draw so much current that the software current limit operates, which may turn the input off. Turning the short circuit on does not affect the programmed settings, and the load input will return to the previously programmed values when the short is turned off

Input On/Off

Electronic load's input can be toggled on/off at the front panel. Turning the input off (zero current) does not affect the programmed settings. The input will return to the previously programmed values when the input is turned on again.

NOTE: The Input On/Off command supersedes the mode commands and Short Test On/Off command.

Operation Range

Work in the range of Rated Current, Rated voltage and Rated Power, The figure is as following:

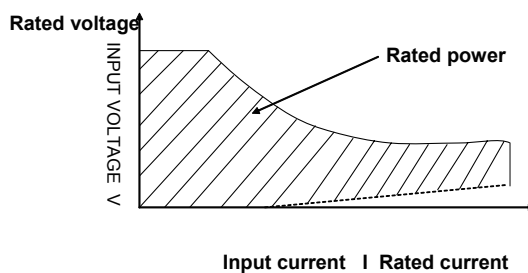

Operation mode change state

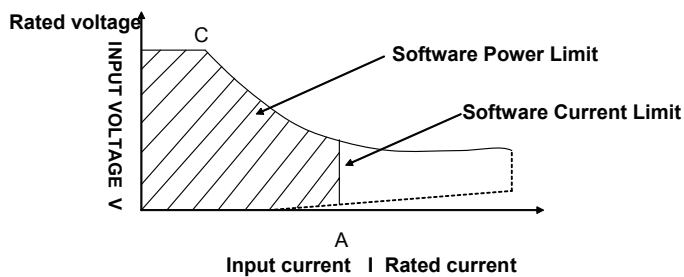

Protection Features

Electronic load includes the following protection features:

Over Voltage

If input voltage exceeds the voltage limit set by the user, the DC load will turn the input OFF and the buzzer will turn on. The display will show OVER VOLTAGE as following. The maximum voltage limit value is equal to 100%+5% of the maximum rated voltage for each model.



OVER VOLTAGE

Over Current

When operating in CR, CC or CP mode, the load current will be limited by a current limit value set by the user. The maximum current limit value is equal to the maximum rated current for each model. Once the maximum current limit is reached, the DC Load will enter the over current protection state. If the DC load previously operated CR or CP mode, the DC load will automatically revert to CC mode and the VFD display will indicate CC. When the DC load operates in a combined CV / transition mode or CV / List mode, the buzzer will sound if the input current exceeds the current limit and the display will show a flashing current value.

Over Power

If the input power exceeds the power limit in the normal operation mode, Load will work in the over power protection state. VFD displays the information as CW. When work in transition mode and list mode, if the input power exceeds the power limit. Buzzer is mooring, VFD display the flashing current value and voltage value.

Reverse Voltage

This feature protects the load module in case the input DC voltage lines are connected with wrong polarity, if a reverse voltage condition is detected, Buzzer is mooring. VFD display as following:



REVERSE VOLTAGE

Over Temperature

If internal power component's temperature exceeds safe limits (80°C), Over temperature protection is on work. Load will turn off the input and Buzzer is mooring, VFD display as following:



OVER HEAT

Remote Sense Function

When work in CC, CV, CR and CP mode, if load consumes biggish current, it will cause one depressed voltage in the connection line between tested machine and terminals of Load. In order to assure testing precision, Load provides one remote testing terminals in the rear panel. Users could test the output terminals voltage of tested machine through it. Users should set the Load in REMOTE mode before using the function.

4 Pin trigger and remote sensing connectors:

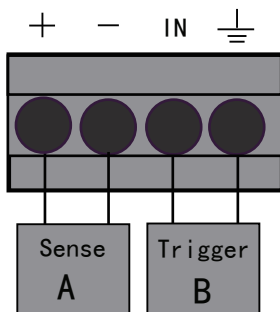

Remote Sensing: SENSE (+) and SENSE (-) are the remote sensing inputs. By eliminating the effect of the inevitable voltage drop in the load leads, remote sensing provides greater accuracy by allowing the load to regulate directly at the source's output terminals.

TRIG: A TTL-compatible input that responds to external edge trigger signal. A trigger applied to this input can be used to change settings (voltage, current, resistance, etc.), toggle between settings in transient-toggle mode, or generate a pulse in transient-pulse mode. You must set the remote sense mode in the menu before using the remote sense function.

Action:

- (1) Press **Shift** + **Menu** key into the menu
 - (2) VFD displays **>CONFIG**, press **Enter** key to confirm
 - (3) Press **▽** key to choose **>REMOTE SENSE**, press **Enter** key to confirm
 - (4) Press **△** / **▽** to choose **>ON**, press **Enter** key to confirm
- And the remote sense function has been set.

Wiring diagram for remote sense

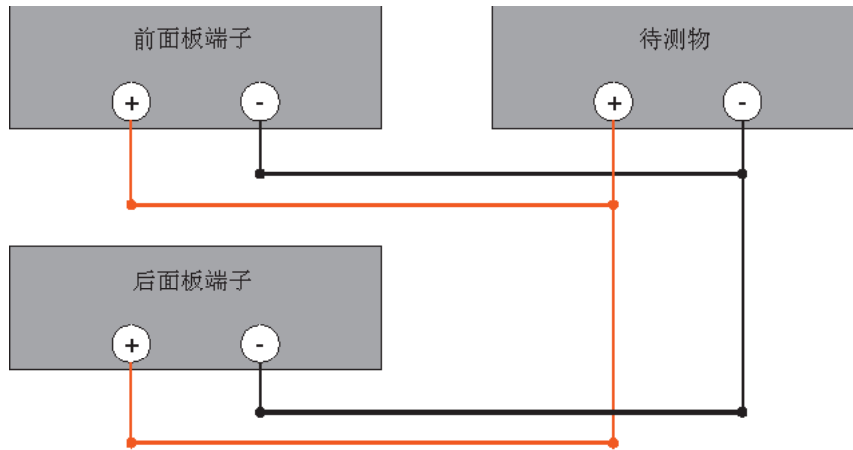

Saving and Recalling Settings

The electronic load has internal registers in which settings (mode, current, voltage, resistance, transient level, etc.). Users could use **Shift** + **Store** and **Shift** + **Recall** to save and recall the relative data as following:

CC value /CW value /CR value /CV value

Transition current A value /Transition current B value /Transition voltage A value /Transition voltage B value / Transition power A value /Transition power B value /Transition Resistance A value /Transition Resistance B value

Current A pulse width time/ Current B pulse width time/Voltage A pulse width time/ Voltage B pulse width time /Power A pulse width time/Power B pulse width time /Resistance A pulse width time /Resistance B width time

Transition current testing mode/Transition voltage testing mode/Transition power testing mode /Transition resistance testing mode

Max current value / Max voltage value / Max power value

Action

- 1) Press **I-set** , set a value of current or voltage, press **Enter** to confirm.
- 2) Press **Shift** + **Store** set a store code at random, press **Enter** to confirm.
- 3) Press **Shift** + **Recall** , set the store code that you set before, press **Enter** to confirm, then you can get the number stored.

Battery Testing

Experiment proves the test with load is the best method to ensure the battery whether work well or not. Only with the correct load testing, the battery can be confirmed if it was being the expectant life curve location. The electronic loads can be used to test any type of the battery nowadays.

As the accumulator is used by any sheltered equipment or the uninterrupted service system, it is necessary to use the load testing. Because the battery nearly is the lowest reliability component, so it must use the load testing periodic ensure the security of the battery.

Capability test

Electronic load uses CC mode to do the capability test. Make a program to set the voltage in off state. The accumulator have too low voltage, electronic load intermits test if system checks the accumulator which is near to one rating or in insecurity state. In testing procedure, you could see the accumulator voltage, discharge current, electronic load power and spare capability of accumulator. If connecting with PC software, discharge curve could be displayed in window. This test can reflect the reliability and using time of accumulator. So, it's necessary to do the test before you change another new accumulator.

Operation:

1. Turn off the load, connect with the tested battery.
 2. Press **I-set** VFD display CURRENT= *****A. Setting the discharge current of the battery, then press **Enter** to confirm.
 3. Press **Shift** + **Battery**, VFD display MIN VOLT= *****V, Setting the voltage when turned off, Press **Enter** to start the capacity testing. When the battery voltage is same as the voltage without power, the load turns off.
- During the testing, use **▼** and **▲** to change the voltage, actual discharge current, the electronic load power and the released discharge capacity of the battery.
4. Then press **Shift** + **Battery**, exit the battery capacity testing mode.

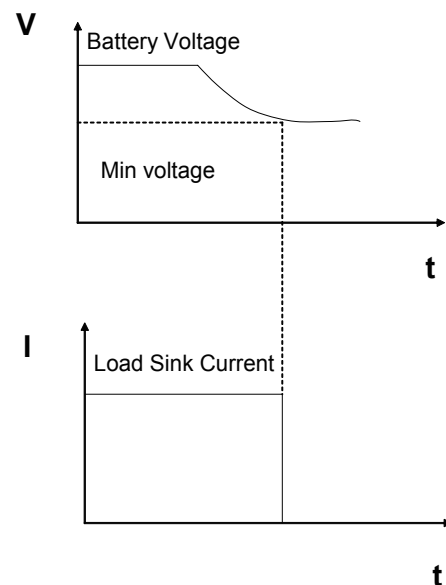

Von/Voff Operation

You can set voltage value Von/Voff to control the input state on/off for electronic load. When the input voltage reaches the Von value, the load's input state is on. When the input voltage reaches the Voff value, the load's input state is off.

Action for set Von/Voff value:

1. Press **Shift** + **Menu** into menu.
2. VFD displays >CONFIG, press key **▼** to choose >SYSTEM SET, press **Enter** to confirm.
3. VFD displays >MAX CURRENT SET, press **▼** key to choose >VOLTAGE ON SET, press **Enter** key to confirm.
4. VFD displays >VOLT.ON=0.00V, press numeric keys to set Von value (0.1V to max voltage value), press **Enter** to confirm.
5. Press **▼** key to choose >VOLTAGE OFF SET, press **Enter** to confirm.
6. VFD displays >VOLT.OFF=0.00V, press numeric keys to set Voff value (0V to max voltage value), press **Enter** to confirm.

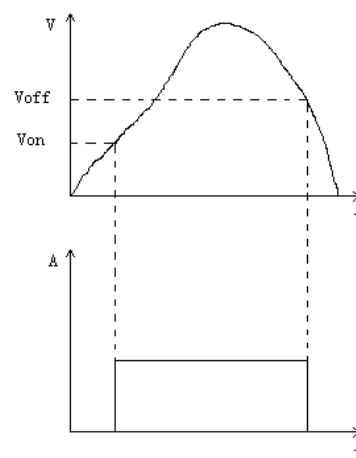

Inspection

Damage

When you receive your electronic load, inspect it for any obvious damage that may have occurred during shipment. If there is damage, notify the shipping carrier and nearest Agent office and Support Office immediately.

Items Supplied

The following user replaceable items are included with your electronic load.

Item	Part Number	Description
Power Cord	IT-E171	Users will get one of the power cords appropriate for your location.
	IT-E172	
	IT-E173	
	IT-E174	
User's Guide		Contains installation, checkout, and front panel information and
Software CD-Rom		Programming information
Calibration Report		The Instrument calibration report.

Cleaning

Use a dry cloth or one slightly dampened with water to clean the external case parts. Do not attempt to clean internally.

Warning: To prevent electric shock, unplug unit before cleaning.

Location

The outline diagram in following figure gives the dimensions of your electronic load. The electronic load must be installed in a location that allows sufficient space at the sides and back of the unit for adequate air circulation.

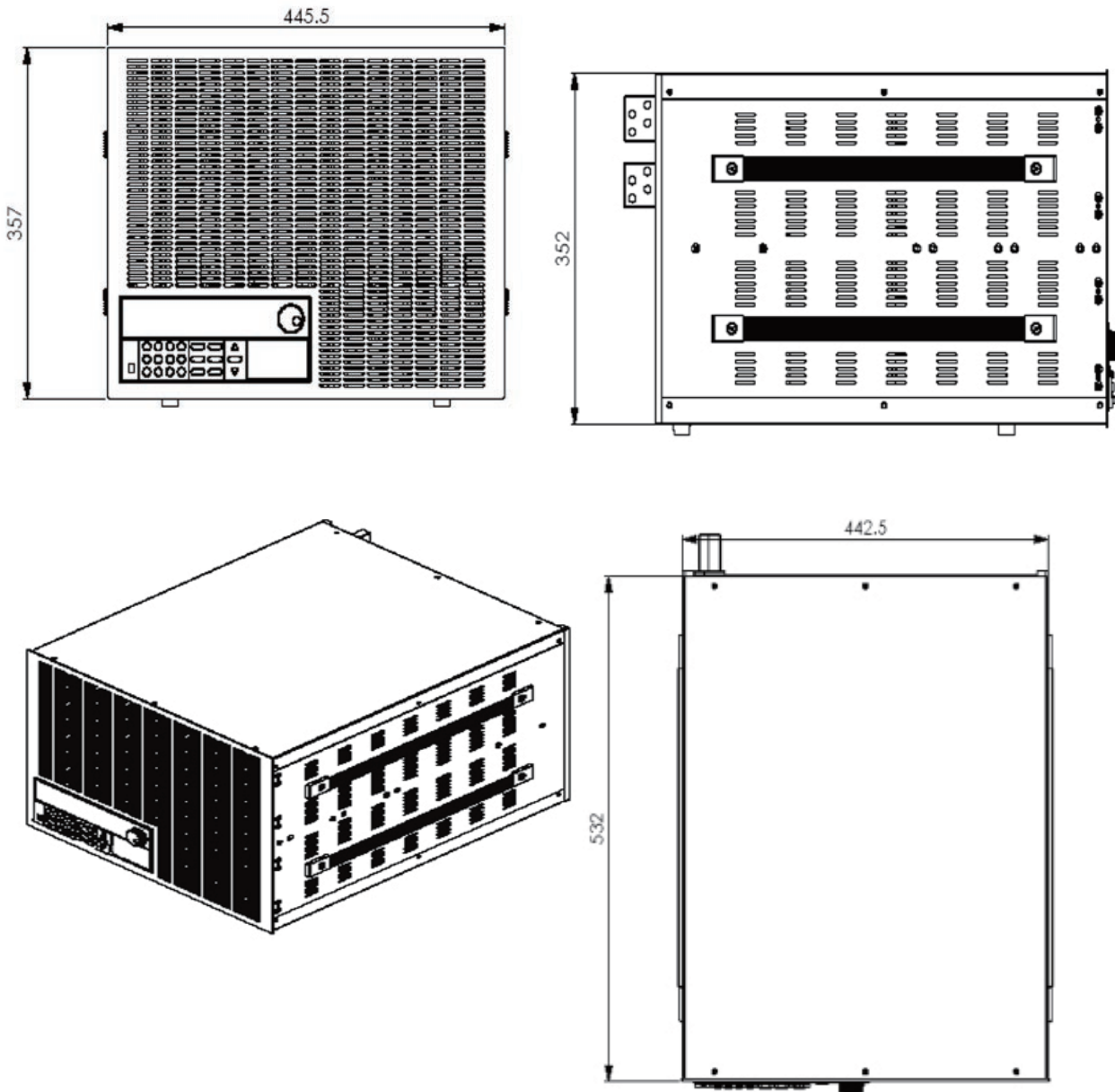

Outline Diagram Unit (mm)

Bench Operation

A fan cools the electronic load by drawing air through the button and sides and exhausting it out the back.

Minimum clearances for bench operation are 25 mm along the sides.

Caution: Do not block the fan exhaust at the rear of the Load.

Input Connections

Power Cord

Connect the power cord to the IEC 320 connector on the rear of the unit. If the wrong power cord was shipped with your unit, contact your nearest Agent to obtain the correct cord. See following figure for the part number and ordering options.

Warning: SHOCK HAZARD: the power cord provides a chassis ground through a third conductor. Be certain that your power outlet is of the three-conductor type with the correct pin connected to earth ground.

Note: The detachable power cord may be used as an emergency disconnecting device. Removing the power cord from the ac input connector will disconnect ac input power to the unit.

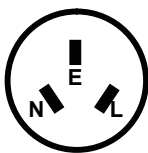

China
IT-E171



United States, Canada
IT-E172

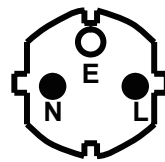

Europe
IT-E173

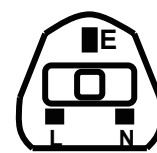

United Kingdom
IT-E174

Introduction

Successful tests in this chapter provide a high degree of confidence that the electronic load is operating properly.

Checkout Procedure

The test in this section checks for proper operation of the electronic load. If you have not already done so, connect the power cord to the unit and plug it in.

Procedure	Display	Explanation
1. Turn the unit on. The electronic Load undergoes a self-test when you First turn it on.		During self test, all segments are briefly lit
2. Wait for 1s after turn on electronic load.	EEPROM ERROR	EEPROM damage or Lost data of last power off Run well if no such display, system will go to the step 3 directly.
3. Wait for another 2S.	ERROR CAL.DATA	EEPROM Lost calibration data Run well if no such display, system will go to the step 4 directly.
4. Press Shift button and Δ / ∇ keys .	LOAD MODEL:IT85XX SN: XXX-XXX-XXX VER x.xx	Display the information of the product Type, series number version of software.
5. Press Esc button	0.000V 0.000A	Display the actual input voltage and current value.
6. Press Δ / ∇	0.000W I: 0.000A	Display the actual power value and setting value.

In Case of Trouble

Electronic load failure to run during power-on operation. The test of following in this section help you to solve the possible problem when you turn on the power of electronic load.

1. Make sure if you have connected the power cord to the unit and plug it in. Power switch have been pressed.
2. Check the power voltage setting.
Work voltage of load have two type 110V or 220V , Please make sure it is right voltage accordance to the voltage in your area. You could change the voltage setting through dial the switch in the rear panel.
3. Check the fuse of load.

If fuse is blowout, please change it as following specification.



Model	Fuse specification(110VAC)	Fuse specification(220VAC)
IT8518B	5AT 250V	2.5AT 250V
IT8518C	5AT 250V	2.5AT 250V
IT8518E	5AT 250V	2.5AT 250V
IT8518F	5AT 250V	2.5AT 250V

Example

I-set (set up a constant current from 0 to Max current)

Set up a constant DC current input is the first main function of programmable DC electronic load,

IT8500 series electronic load provides two methods to set up the constant DC current input by using the number keyboard and the rotary button. Please see the following operation procedure.

Procedure	Operation details	VFD display
Step 1	Press 	CURRENT=0.000A
Step 2	Enter the password or jump the step 4 if your password for reentering	PASSWORD:
Step 3	Enter the original value which displayed in the LCD or enter a new value by using number keys or Rotary knob to adjust the voltage value	CURRENT=*.***A
Step 4	Press  to confirm	0.00V 0.000A

Setup the input current at 4.33A.

Method 1: To set up by using number keyboard

Step1. Press  button.

Step2. Press numeric button to enter the current value 4.33.

Step3. Press  button to confirm the current value.

Method 2: To set up by using Rotary SW

If the key board is unlocked by password, directly adjust the Rotary SW button, and voltage will be continually changed from the previews value according the rotation. At the beginning, the cursor will be shown on the last number of the value which is indicated on the VFD, you can move the cursor to the first number, second number etc by using number buttons, and then adjust the Rotary SW to change each number, and let it stay at *.** A. Please see the following description. Then press I-set to confirm the value.

0.00A 0.00V

0.0W 4.33A

Procedure:

Step1. Press  button,

Step2. Adjust the Rotary knob to change the value, the operation is as the same as item (1)

Step5. Press  button to confirm the current value.

P-set (set up a constant power from 0 to Max power)

IT8500 series electronic load can be set up for a constant power.
Constant power setup procedure is as following:

Procedure	Operation details	VFD display
Step 1	Press P-set	POWER =0.0W
Step 2	Enter a new value by using numeric keys or Rotary knob to adjust the voltage value	POWER=*.***W
Step 3	Press Enter to confirm.	0.000W P:*.000W

R-set (set up a constant resistance from 0.1Ω to 4000Ω)

IT8500 series electronic load can be setup for a constant resistance.
Constant resistance setup procedure is as following:

Procedure	Operation details	VFD display
Step 1	Press R-set	RESISTANCE =0.0R
Step 2	enter a new value by using numeric keys or Rotary knob to adjust the resistance value	RESISTANCE=*****R
Step 3	Press Enter to confirm.	0.000W R:0000R

V-set (set up a constant voltage from 0.1V to Max voltage)



IT8500 series electronic load can be setup for a constant voltage.
Constant voltage setup procedure is as following:

Procedure	Operation details	VFD display
Step 1	Press V-set	VOLTAGE=1.500V
Step 2	enter a new value by using numeric keys or Rotary knob to adjust the resistance value	VOLTAGE=*.***V
Step 3	Press Enter to confirm.	0.000W V:3.000V

Shift + Store

Procedure	Operation details	VFD display
Step 1	Press  and 	STORE 1
Step 2	Press  to confirm.	Store the relative data



Shift + Recall







Procedure	Operation details	VFD display
Step 1	Press  and 	RECALL 1
Step 2	Press  to confirm.	Recall the saving data

In On/Off input setting

Use  to change the input state of electronic load. Switch on to off state by press 

Transition Parameter Setting

Users could press  +  to set the transition parameter.

 + 	LEVEL A =0.000A	Setup value A
	WIDTH A = 0.5mS	Setup time width of value A
	LEVEL B=0.000A	Setup value B
	WIDTH B= 0.5mS	Setup time width of value B
	>CONTINUOUS >PULSE >TOGGLED	Choose one of the three transition modes
		Finish transition setting

Continuous Transient Operation

In this mode, electronic load will generate a repetitive pulse stream that toggles between two load levels. ; Load could switch the state between two setting value (value A and value B).

In this following example, assume that the CC mode is active; the applicable transient operation parameters have been set as follows.

For example:

Continuous mode, current level A =5A, width = 2mS. Current level B =10A, width = 3ms. Testing machine input voltage is 12V.

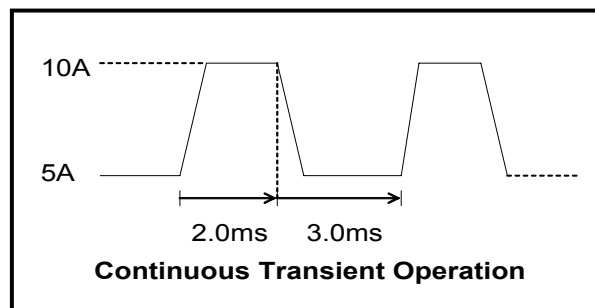

Action

1. Select the operation mode (CC,CV,CR or CP), and set a proper value, press **On/Off** to turn off the load input.
2. Press **Shift** + **S-Tran**, set LEVEL A=5A, press **Enter**, set WIDTH A=3mS, press **Enter** set LEVER B=10A, press **Enter**, set WIDTH B=2mS, press **Enter** to confirm.
3. Transition mode now is CONTINOUS, press **Enter** to confirm.
4. Press **Shift** + **Tran** to activate the transient mode.
5. Press **Shift** + **Tran** again to stop the transient operation.
6. Press **On/Off**, the input of load is powered on.

Pulse Transient Operation

In this mode, generates a transient pulse of programmable width when pulsed transient operation is in effect.

For example: When load receiving one trigger signal, it will switch to 10A current value, and taking 10mS to return the current value of 5A.

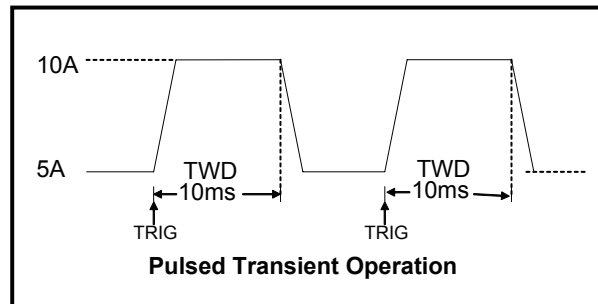

Action

1. Select the operation mode (CC,CV,CR or CP), and set a proper value, press **On/Off** to turn off the load input.
2. Press **Shift** + **S-Tran**, set LEVER A=5A, LEVER B=10A, WIDTH B=10mS. Transition mode now is CONTINUOUS.
3. Press **▼** till >PULSE.
4. Press **Enter**, set transient mode is PULSE.
5. Press **Shift** + **Tran** to activate the transient mode.
6. Press **Shift** + **Trigger** to start another pulse. Press **Shift** + **Trigger**, get more pulse.
7. Press **Shift** + **Tran** again to stop the transient operation.
8. Press **On/Off**, the input of load is powered on.

Toggled Transient Operation

In this mode, after transition operation start, Load could change the input between the main level and the transient level when toggled transient operation is in effect.

For example:

When Load receives one trigger signal, Load current will switch between 5A and 10A.

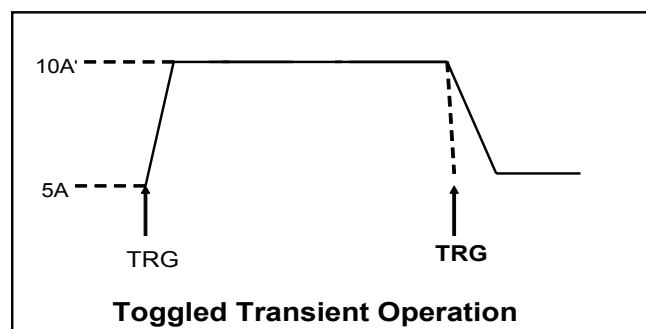

Action

1. Press **Shift** + **S-Tran**, Setting LEVER A=5A, LEVER B=10A, transition mode is TOGGLED.
2. Press **Shift** + **Tran** to activate the transient mode.
3. Press **Shift** + **Trigger** switch to the current value of 10A.
4. Press **Shift** + **Trigger** switch between 5A and 10A.
5. Press **Shift** + **Tran** again to stop the transient operation.

List Operation

Users can use the front panel keypad or Power View 8500(PV8500) software to programming the list sequence. Please refer to the software user's guide.

The following example will help you how to do the list operation in front panel.

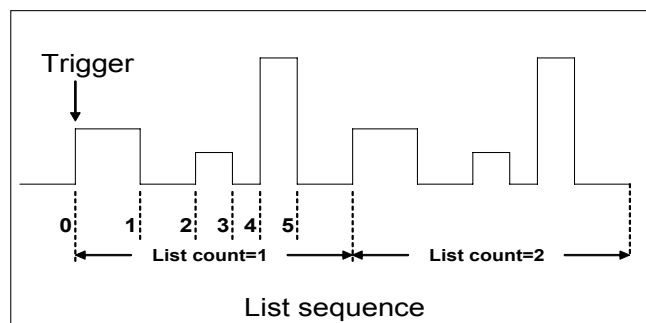

Action

- 1) Press the button of **On/Off**, execute the input of Load I in OFF state.
- 2) Press **Shift** + **Menu**, move cursor to the option of menu of CONFIG, Press **Enter** into the next step menu, move cursor to TRIGGER SOURCE. Press **Enter** and move cursor to IMMEDIATE <DEF>, setting trigger source mode is panel IMMEDIATE mode.
- 3) Press **Enter** to confirm.
- 4) Press **Esc** to the previous menu, move cursor to LIST SET.
- 5) Press **Enter** into the next step menu .move cursor to EDIT LIST FILE.
- 6) Press **Enter** into the next step menu, move cursor to CURRENT LIST, select CURRENT MODE.
- 7) Press **Enter**, move cursor to REPEAT. Setup LIST is in cycle mode.
- 8) Press **Enter** to confirm, setup the list steps = 5.
- 9) Press **Enter** to confirm, setup step 1 current =3A.

Action

- 10) Press **Enter** to confirm, setup step 1 width=6mS.
- 11) Repeat 7) and 8) operation , set current and width of one step 0A, 5mS;2A, 4mS;6A,2mS;0A,5mS.
- 12) Press **Enter** to confirm, Menu STORE LIST FILE 1, save file in group1.
- 13) Move cursor to Mode Set , press **Enter** to enter into the next step menu to set mode is <LIST MODE >
- 14) Press **Enter** to confirm
- 15) Press **Esc** , Press **On/Off** , make Load in ON state. Press **Shift** + **Trigger** , make list operation run or stop.
- 16) Stop the list operation mode. Move cursor to LIST SET, press **Enter** , move cursor to Mode Set in option menu, press **Enter** , enter into next step menu. Select mode is <FIXED MODE>.
- 17) Press **Enter** to confirm.

Fast Recall Function

You recall 10 groups numbers very conveniently which were stored before.

Action

- 1) Press **Shift** + **Menu**
- 2) Press **▼** to CONFIG, press **Enter** into submenu, press **▼** to SHORTCUT RECALL
- 3) Press **Enter** , select >ON and press **Enter** to confirm.
- 4) Press **Esc** two times and quit the menu.
- 5) Press **1** and you can get the first group number. Press **2** , you can get the second group number. Press **0** , you can get the tenth group number. And if there is not stored number, VFD will show NO EEPROM DATA.

Automatic Testing Function of Electronic Load

You test various parameters of power supplies at different loads. Now we take a kind of charger as an example to explain the usage of the automatic testing of the electronic load.

The test proceeding of R35 charger					
process	Method				
	Mode	Voltage(V)	Current(mA)	Power(W)	Ripple counter
1st step	CC	5.8~6.15	210	≤4(input175VAC)	≤ 50mVpp
2nd step	None	5.9~6.4	0	≤1.2(input175VAC)	
3rd step	CC	5	205~245		
4th step	CV	3	205~245		
5th step	CV	2	205~245		
6th step	Short circuit	0	≤245		

Edit the Testing File

- 1) Press **Shift** + **Menu** into menu, VFD displays >CONFIG
- 2) Press **▼** to >LIST SET.
- 3) Press **Enter** into submenu, press **▼** to >EDIT LIST FILE.
- 4) Press **Enter** and begin to edit the automatic testing file, VFD shows MAX CURR=20.000A, which means setting the maximum of voltage. The maximum is bigger than 3A, which means CC mode is in high range, here, the maximum is 3A. Press **3** and press **Enter** to confirm.
- 5) VFD displays MAX VOLT=120.00V, which means setting the maximum of voltage, the maximum is bigger than 18V, which means CV is in high range, here, the maximum is 18V. Press **1** + **8** to set MAX VOLT=18V, press **Enter** to confirm.
- 6) VFD displays MAX POWER=200.00W, which means setting the maximum of power, here, it is 150W, Press **1** + **5** + **0** to set MAX POWER=150W, press **Enter** to confirm.
- 7) VFD displays TEST COUNT=2, which means setting steps of testing, 20 steps are permitted at most, here, they are 6 steps. Press **6** to set TEST COUNT=6, press **Enter** to confirm.
- 8) Setting the mode of current procedure, press **▲**、**▼** to choose one mode in CONST CURRENT、CONST VOLTAGE、CONST POWER、CONST RESIS. Here, the first step is CC mode, press **▲**、**▼** to >CONST CURRENT, press **Enter** to confirm.
- 9) VFD shows SET 1=20.000A, which means setting the current procedure. Here, the first is 0.21A, press **0** + **2** + **1**, then press **Enter** to confirm.
- 10) Setting whether the current procedure is short circuit or not, press **▲**、**▼** to choose one in SHORT ON or SHORT OFF. Here the first step is SHORT OFF. Press SHORT OFF, press **Enter** to confirm.
- 11) Select the test number of this step, press **▲**、**▼** to choose >READBACK V, Press **Enter** to confirm.
- 12) VFD displays MIN 1=120.00V, which means setting the lower limit. Here, the first step is 5.8V. Press **5** + **8**, press **Enter** to confirm.

- 13) VFD displays MAX 1=120.00V, which requests setting the upper limit. Here, the first step is 6.15V, press (6) + (•) + (1) + (5), then press (Enter) to confirm.
- 14) VFD shows DELAY 1= 1.0 (S) , which means setting the prolong time, that is how long we can read the testing value after inputting the value we settled. To wait for testing after the input stable, the range of prolong time is 0~25.5 seconds, when the setting is 25.5 seconds, automatic testing will be pause, only the user press (Shift) + (Trigger) ,the testing will continue. Here, the first step is 1 second, press (1) and then press (Enter) to confirm.
- 15) Repeat 9)~14), and set the other process step by step as follows:
- A. CONST CURRENT,0A,SHORT OFF, READ BACK V, 5.9V, 6.4V,1S
 - B. CONST VOLTAGE, 5V, SHORT OFF,READ BACK A, 0.205A, 0.245A,1S
 - C. CONST VOLTAGE, 3V, SHORT OFF, READ BACK A, 0.205A,0.245A,1S
 - D. CONST VOLTAGE, 2V,SHORT OFF, READ BACK A, 0.205A,0.245A, 1S
 - E. CONST CURRENT, 0A, SHORT ON, READ BACK A,0A,0.245A, 1S
- 16) VFD displays SHORT TEST FILE*, which requests saving the files edited to EEPROM, automatically testing files and LIST files use a common memory area, and the area can contain 8 groups of automatic testing files for next usage. Here, the testing file could be saved in the first group, press (1) and press (Enter) to confirm.
- 17) When the edition of automatic testing file is finished, press (Enter) two times to back the menu.

Fast Recall the Test File

- 1) Press (Shift) + (Menu) to enter into menu, VFD displays>CONFIG
- 2) Press (▼) and move the menu to>LIST SET
- 3) Press (Enter) to enter into submenu, VFD displays>MODE SET
- 4) Press (▼) and move the menu to>CALL TEST FILE
- 5) Press (Enter) and recall the file edited

Automatic Testing

After editing the automatic testing file, the automatic testing could be carried out by the below steps.

- 1) Press (Shift) + (I-set) to enter into automatic testing, VFD displays the name of current file: NAME: TEST FILE1
- 2) Press (Enter) to observe the voltage and current we inputted, and also can observe the step number of testing.
- 3) Press (Shift) + (Trigger) and begin to operate, when the automatic testing is pause (the current prolong time of one step is 25.5S), press (Shift) + (Trigger) also can make the testing continue.

- 4) When the automatic testing is finished, the buzzer will hint by tweet (buzzer), VFD reads the result of testing. If the testing passed, VFD reads PASS, or reads FAULT. Press ▲、▼ also to observe the numerical value and result of every step.
- 5) Press **Esc** to back the automatic testing.

Select the Resolution between Low Range and High Range

- 1) Press **Shift** + **Menu** to enter into menu, VFD displays>CONFIG
- 2) Press **Enter** into the submenu, VFD displays>INITIAL CONFIG
- 3) Press ▼ to make VFD display RANGE SELECT
- 4) Press **Enter** to confirm, and press ▼ to choose ON
- 5) Press **Enter** to confirm
- 6) Press **Esc** to exit menu

Then you can press **Shift** + ▲ to change the voltage range (maximum voltage). If the former maximum voltage value is 120V and the resolution is 10mV, it will become 18V when you press **Shift** + ▲ , and you will get 3 decimal points (xx.xxx) compared to 2 decimal points before. Whereas if the former maximum voltage is 18V, you can press **Shift** + ▼ to make it become 120V, also the resolution will become as 10mV.

On the other hand, you can press **Shift** + ▼ to change the current range (maximum current). If the former maximum current value is 12A and the resolution is 1mA, it will become 120A when you press **Shift** + ▼ , and you will get 2 decimal points (xx.xx) compared to 3 decimal points before. whereas if the former maximum current is 120A, you can press **Shift** + ▼ to make it become 12A, and the resolution will become as 1mA.

Specifications

Parameter		IT8518B	IT8518C	IT8518E	IT8518F
Input rating (0 ~ 40 °C)	Voltage	0~500V	0 ~ 60V	0 ~ 60V	0~60V
	Current	1mA~120A	1mA ~ 240A	1mA ~ 240A	1mA ~480A
	Power	5000 W	5000W	6000W	5000W
Load Regulation	Range	Accuracy	Resolution	Accuracy	Resolution
	0~18V	$\pm(0.05\%+0.02\%FS)$	1mV	$\pm(0.05\%+0.02\%FS)$	1mV
	0~60V/500V	$\pm(0.05\%+0.025\%FS)$	10mV	$\pm(0.05\%+0.025\%FS)$	10mV
	0~12A/24A/48A	$\pm(0.1\%+0.1\%FS)$	1mA	$\pm(0.1\%+0.1\%FS)$	1mA
CV Mode Regulation	0~120A/240A/480A	$\pm(0.2\%+0.15\%FS)$	10mA	$\pm(0.2\%+0.25\%FS)$	10mA
	0.1~18V	$\pm(0.05\%+0.02\%FS)$	1mV	$\pm(0.05\%+0.02\%FS)$	1mV
CC Mode Regulation	0.1~60V/500V	$\pm(0.05\%+0.025\%FS)$	10mV	$\pm(0.05\%+0.025\%FS)$	10mV
	0~12A/24A/48A	$\pm(0.1\%+0.1\%FS)$	1mA	$\pm(0.1\%+0.1\%FS)$	1mA
CR Mode Regulation Input current $\geq FS$ 10% Input Voltage $\geq FS$ 10%	0~120A/240A/480A	$\pm(0.2\%+0.15\%FS)$	10mA	$\pm(0.2\%+0.25\%FS)$	10mA
	0.1~10 Ω	$\pm(1\%+0.3\%FS)$	0.001 Ω	$\pm(1\%+0.3\%FS)$	0.001 Ω
	10~99 Ω	$\pm(1\%+0.3\%FS)$	0.01 Ω	$\pm(1\%+0.3\%FS)$	0.01 Ω
	100~999 Ω	$\pm(1\%+0.3\%FS)$	0.1 Ω	$\pm(1\%+0.3\%FS)$	0.1 Ω
CW Mode Regulation Input current $\geq FS$ 10% Input Voltage $\geq FS$ 10%)	1K~4K Ω	$\pm(1\%+0.8\%FS)$	1 Ω	$\pm(1\%+0.8\%FS)$	1 Ω
	0~100W	$\pm(1\%+0.1\%FS)$	1mW	$\pm(1\%+0.1\%FS)$	1mW
Current Measurement	100~5000/6000W	$\pm(1\%+0.1\%FS)$	100mW	$\pm(1\%+0.1\%FS)$	100mW
	0~12A/24A/48A	$\pm(0.1\% + 0.1\%FS)$	1mA	$\pm(0.1\% + 0.1\%FS)$	1mA
Voltage Measurement	0~120A/240A/480A	$\pm(0.2\%+0.15\%FS)$	10mA	$\pm(0.2\%+0.25\%FS)$	10mA
	0~18V	$\pm(0.02\% + 0.02\%FS)$	1mV	$\pm(0.02\% + 0.02\%FS)$	1mV
Power Measurement Input current $\geq FS$ 10% Input Voltage $\geq FS$ 10%	0~60V/500V	$\pm(0.02\% + 0.025\%FS)$	10mV	$\pm(0.02\% + 0.025\%FS)$	10mV
	0~100W	$\pm(1\%+0.1\%FS)$	1mW	$\pm(1\%+0.1\%FS)$	1mW
Battery testing function	100~5000/6000W	$\pm(1\%+0.1\%FS)$	100mW	$\pm(1\%+0.1\%FS)$	100mW
	Input=0.1~60V/500V Resolution =10mA		Max measurement capacity= 999AH Timer range=1~60000sec		
Transition Mode	Range of Frequency 0.1Hz~1kHz Frequency error rate<0.5%				

Remote Operation Mode

DB9 in the rear panel of electronic load could connect with RS-232 through on TTL connector. The following information may help you to know how to control the output of electronic load through PC.

1 Communication cable

IT-E131 RS232 Communication cable

The DB9 interface connector on the rear panel of electronic load is TTL voltage level; you can use the communication cable (IT-E131) to connect the DB9 interface connector of the electronic load and the RS-232 interface connector of computer for the communication.

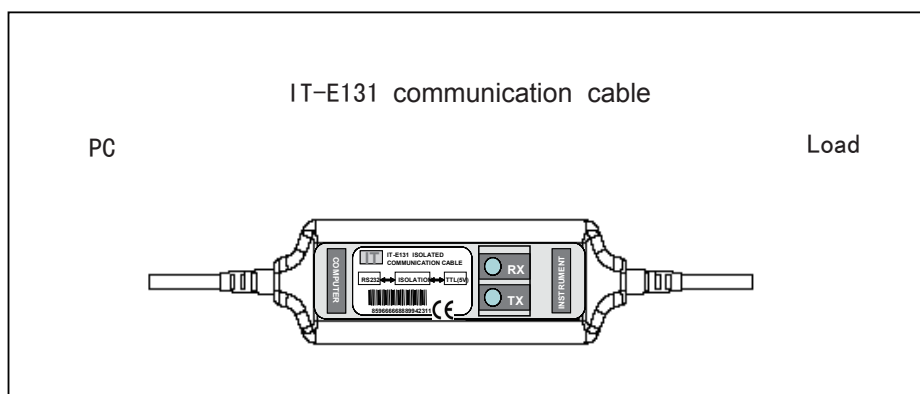

IT-E132 USB Communication cable

The DB9 interface connector on the rear panel of electronic load is TTL voltage level; you can use the communication cable (IT-E132) to connect the DB9 interface connector of the electronic load and the USB interface connector of computer for the communication.

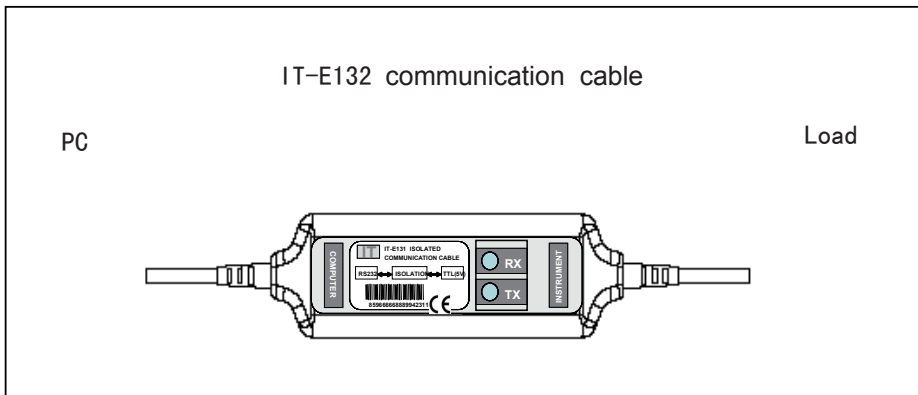

IT-E134 GPIB Communication Cable

The DB9 interface connector on the rear panel of electronic load is TTL voltage level; you can use the communication cable (IT-E134) to connect the DB9 interface connector of the electronic load, and then connect GPIB interface connector of IT-E134 cable and computer with GPIB/IEEE 4888 line for the communication.

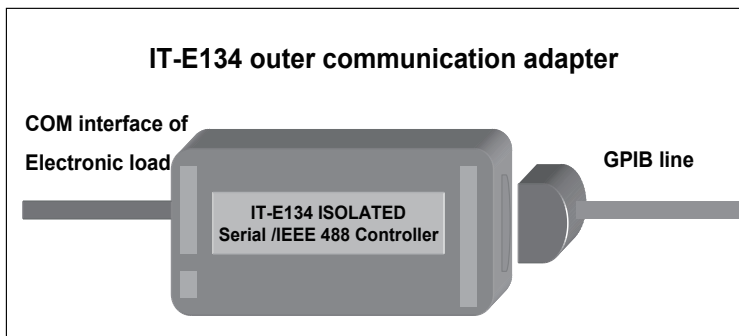

Note: Forbidden to connect DB9 connector in electronic load directly with PC or other RS232 port.

2 Communication between electronic load and PC

Before using the remote operation mode, please make sure that the baud rate and communication address in electronic load are the same as in the computer software, otherwise, the communication will fail, you can change the baud rate and communication address from the front panel or from computer.

1. Address: the range is from 0 to 254, default setting is 0
2. Baud rate: 4800,9600,19200 and 38400 are selectable
3. Data bit: 8 bit
4. Stop bit: 1
5. Parity: None

Parity=None	Start Bit	8 Data Bits	Stop Bit
-------------	-----------	-------------	----------

DB9 Interface Details

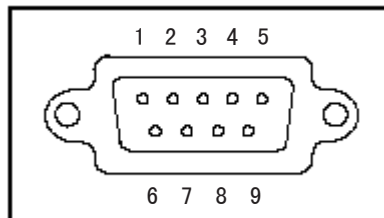

DB9 in the rear panel of electronic load is TTL level signal .it can be connecting with standard PC interface through the IT-E131 isolated communication cable.

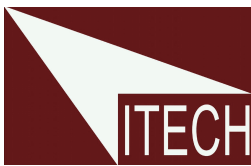

ITECH Electronic Co., Ltd

China

Tel : 025-52415098

Fax: 025-52415268

310# Ning Nan Da Dao,
NanJing City, 210012, Jiangsu
Province,China

USA

Tel : 714-9219095

Fax: 714-9216422

22820 Savi Ranch Parkway
Yorba Linda, CA 92887 U.S.A.

Europe

Tel : 477-590101

Fax: 477-572323

32, rue Edouard Martel
42100 - St Etienne France

South Korea

Tel : 285-20680

Fax: 285-20684

#153-783,Rm601,ByuckSan,
GaSan-Dong, Seoul, Korea